

QUICK START GUIDE

DishDrawer™ dishwasher (Integrated)

NZ AU US CA

Fisher & Paykel

Selecting a wash program

Keep this document handy for easy reference.

- For detailed information on the features of your dishwasher, see your 'User guide'.
- Before using your dishwasher, make sure you read the full 'User guide', with special attention to the 'Safety and warnings' section.
- For contact information or if you require service, assistance or replacement parts, see the end of this document or your 'Service & warranty' booklet.

Your model

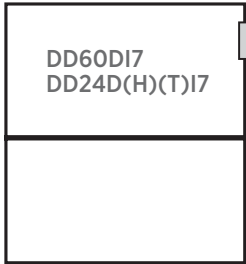

Note: each drawer in double models has its own controls and can run independently of the other drawer.



Your remote control

Important!

To prevent unauthorized use, keep the remote control out of reach of children.

Signal indicator

- A single flash indicates a successful signal to the dishwasher.
- Multiple flashes indicate that the dishwasher cannot read the signal. The remote control may be out of range.

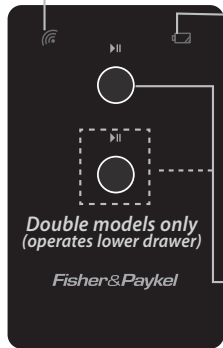

'Battery low' indicator

When this flashes, the battery needs to be replaced. Use a CR2032 battery, ensuring the + symbol faces up.

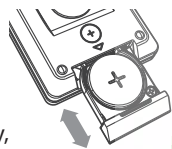

Control button(s)

See section 'Operating instructions' for information.

Mounting your remote

Your remote control comes supplied with a detachable mounting bracket and self adhesive strip. You can choose to affix this bracket on a nearby surface, which should be out of direct sunlight and away from excessive heat and steam. Do not apply on wallpaper.

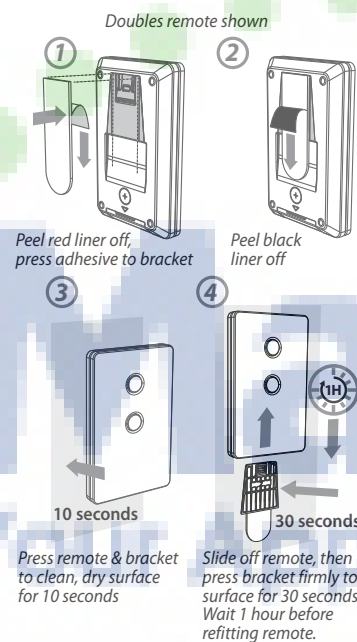

Loading and detergent

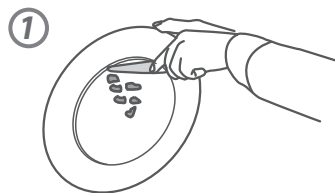

Discard scraps

Scrape large food particles off (e.g. bones, fruit stones) and remove any foreign objects (e.g. toothpicks, strings, paper).

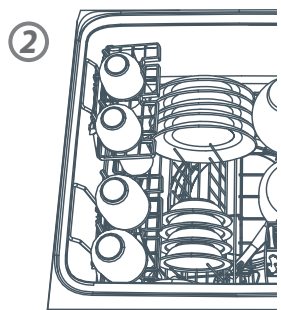

Load dishes carefully

To help with wash performance, arrange dishes so they are evenly spaced and not nesting.

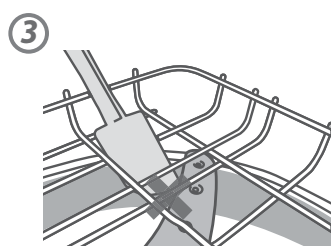

Check spray arm(s)

Ensure there are no items blocking the spray arm(s) from rotating.

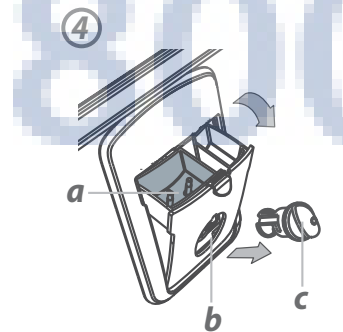

Add detergent and check rinse aid

Fill the detergent dispenser (a) with powdered detergent and close the dispenser door.

Important!

Do not place liquid detergent or tablets in the detergent dispenser.

If the indicator on its plug (c) glows bright red, refill the rinse aid dispenser (b) with liquid rinse aid. Make sure you then refit the rinse aid plug back into its original position.

If using a tablet, place it in the cutlery basket (d) or at the bottom of the drawer.

Operating instructions

You can operate your dishwasher in two ways:

EITHER by using the button on the drawer control panel

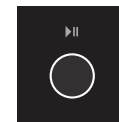

OR by using the remote control button

Start/resume wash	1 Press . 2 Close the drawer. The wash will start.
Pause wash	You can only pause the wash with the remote. See opposite.
Cancel wash	1 Pause the wash with the remote. 2 Open the drawer, then press and hold until you hear a quick double beep. Any water in the drawer will automatically drain when you close it.
Set Delay start	To delay the start of a wash by 1 to 12 hours: ▪ Press and hold . Count the beeps as the dishwasher emits them (each represents 1 more hour of delay) and release the button when you have reached the desired delay time. ▪ The indicator of the selected wash program will flash to show that Delay start has been set. ▪ The wash will start once the delay time is over, provided the drawer is closed.
Cancel Delay start	Press and hold until you hear a quick double beep and the indicator of the selected wash program goes out.

Start/resume wash	1 Close the drawer. 2 Press . The wash will start.
Pause wash	Press . After pausing a wash, wait for 3 beeps before opening the drawer. Forcing it open in mid-cycle may cause damage or injury.
Cancel wash	Press and hold until you hear a quick double beep. Any water in the drawer will automatically drain.
Set Delay start	You can only set Delay start on the drawer control panel. See opposite.
Cancel Delay start	Press and hold until you hear a quick double beep.

Wash program indicators

These show which program is selected.



Wash program selector

Press to scroll through the wash programs.

HEAVY	NORMAL	FAST	DELICATE	RINSE	ECO indicator
STANDARD PROGRAMS - designed to clean and dry your dishes					
HEAVY Heavily soiled pots, pans and dishes.	NORMAL Dishes with normal soils for optimum performance.	FAST Lightly soiled dishes.	DELICATE Lightly soiled and heat sensitive crockery.	RINSE Prevents odors and soils drying on dishes.	ECO indicator The indicator will glow red when an Eco program has been selected. If you require enhanced drying, we do not recommend selecting an Eco program.
ECO PROGRAMS - designed to clean your dishes energy-efficiently					
HEAVY ECO Heavily soiled everyday dishes.	NORMAL ECO Normal soiled dishes for optimum water and energy use.	FAST ECO Lightly soiled, non-greasy dishes.	DELICATE ECO Lightly soiled, non-greasy and heat sensitive crockery.		

After the wash

The dishwasher will beep six times to indicate the end of the wash program.

You may notice the following noises at the end of the wash. These are all part of normal operation:

- In double models, both drawers may be draining simultaneously.
- The drying fan may continue to run after a wash program has finished for a set time. The fan assists with drying and uses negligible amounts of energy.

For best drying results, we recommend unloading the dishes once they have cooled.

Dos and don'ts of loading

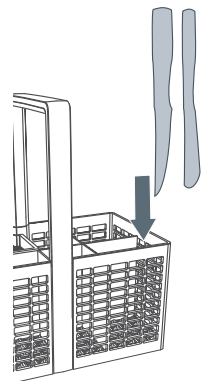

Sharp or pointed items must be placed horizontally or with sharp edges/points facing down to avoid risk of injury.

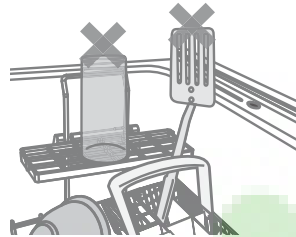

Protruding items will stop the internal lid of the drawer from sealing properly, which could result in a service call.

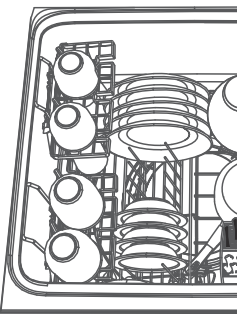

A neatly arranged load with evenly spaced dishes helps wash performance.

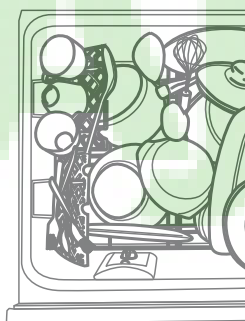

Overcrowding reduces wash performance.

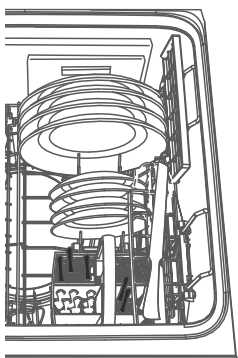

Ensure there is enough space between plates. Mix spoons, knives and forks within the cutlery basket to prevent them from nesting.

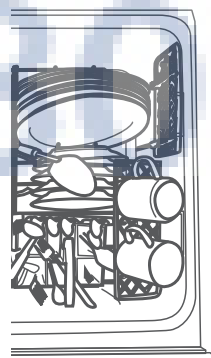

If plates and cutlery are nesting, they are less likely to be cleaned well.

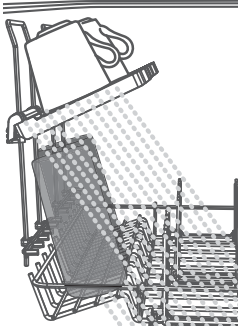

Ensure that water reaches all items on the adjustable racks.

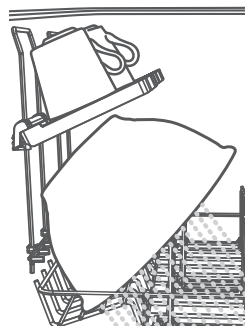

Dishware is blocking water from reaching items on the adjustable racks.

Preference options

You can change the setting of these options to suit your preferences or circumstances. We recommend selecting the most suitable settings before you start using your dishwasher.

Option	Rinse aid	Water softener*	Beeps at end of wash
What does it do?	Regulates the amount of rinse aid dispensed. Reduce this setting if there is excess foam after a wash. Increase this setting if dishes are wet or streaky after a wash.	Refer to the 'Water softener' section of the 'User guide' for details.	Your dishwasher is factory-set to beep six times at the end of a wash. You can turn this setting off.

How to change the setting of an option

1 CHECK & OPEN

Check that there is no wash underway, then open the drawer.

2 ENTER MENU & SCROLL TO OPTION

To enter the menu: press first with one finger, then with another finger, hold both until one long beep sounds, then release.

- You are now in the Rinse aid option of the preference options menu.
- If you want to change the Rinse aid setting, go to step 3 now.
- If you want to change the setting of another option, you will need to scroll to that option first.

To scroll to the next option: press . To know which option you're in, keep track of the sequence of options using the table below. When you have scrolled to the end of the sequence, it will start again with Rinse aid (after the lower tone).

Option	Rinse aid	Water softener*	Beeps at end of wash
Possible settings	1 to 5	0 to 5	On/Off
Example	 4 indicators lit = setting is 4	 3 indicators lit = setting is 3	On HEAVY NORMAL FAST DELICATE RINSE
			Off HEAVY NORMAL FAST DELICATE RINSE

3 CHANGE SETTING

Press to change the setting within an option. For example, to change the Rinse aid setting from 4 (factory default) to 2, you need to press 3 times.

4 SAVE SETTING & QUIT MENU

Press and hold until a beep sounds and the control panel reverts to showing the wash program currently selected.

*This option is disabled on models without water softener. It appears in the sequence of options but cannot be adjusted.

For more info

For detailed information on the features of your dishwasher

see your 'User guide'

For warranty information

see your 'Service and warranty' booklet

If you...

- have any questions or comments
- need a Fisher & Paykel authorized technician to service your product
- need replacement parts or accessories
- want to register your product

see your 'Service and warranty' booklet or contact us

NZ toll-free, 24/7 **0800 372 273**
AU toll-free, 24/7 **1300 650 590**
USA toll-free, 24/7 **1 888 936 7872**
CA toll-free, 24/7 **1 888 936 7872**

www.fisherpaykel.co.nz
www.fisherpaykel.com.au
www.fisherpaykel.com
www.fisherpaykel.ca